

Instructions

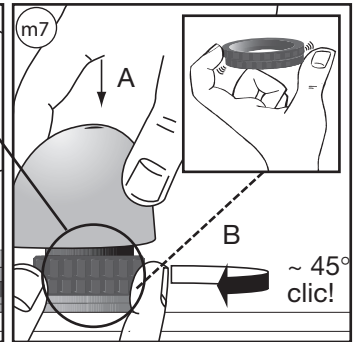

24Vac, ME1605, NO / ME1705 NC
230Vac ME1625 NO / ME1725 NC

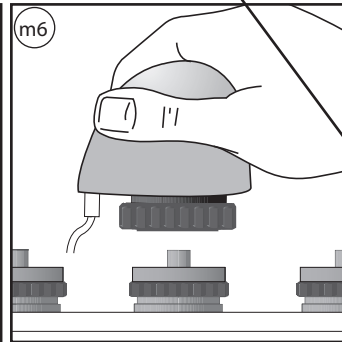
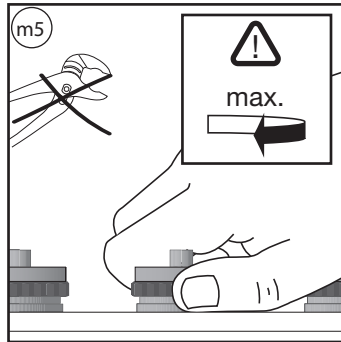
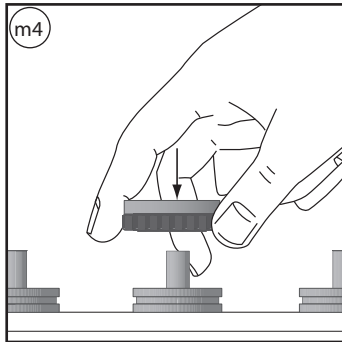
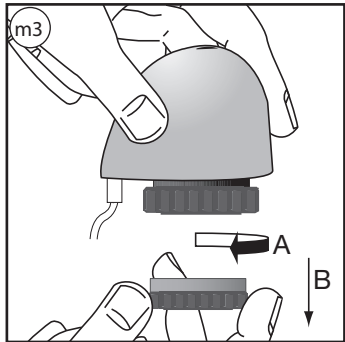
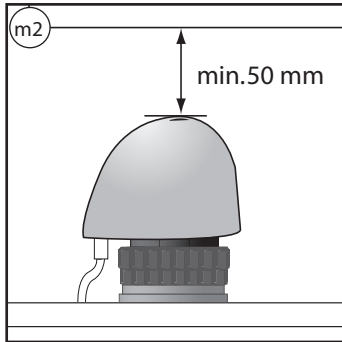
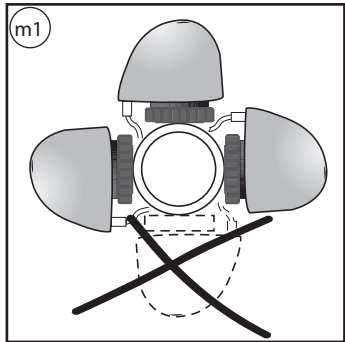
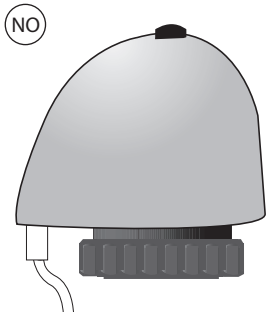
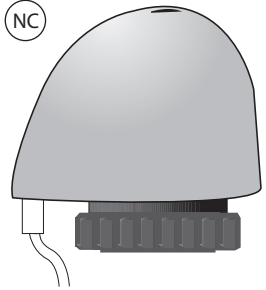

Optical control bayonett lock:
Locking is achieved when the raised edge on both halves of the yoke rings are vertically inline

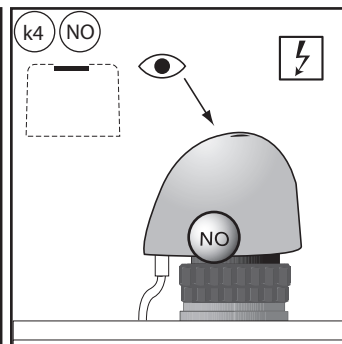
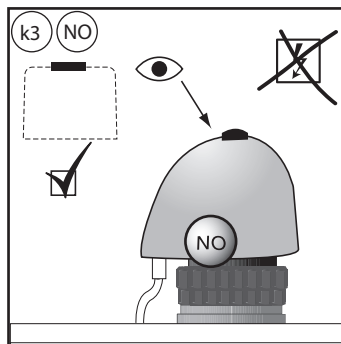
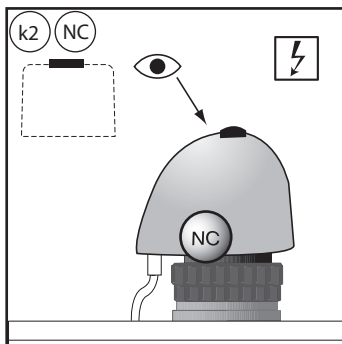
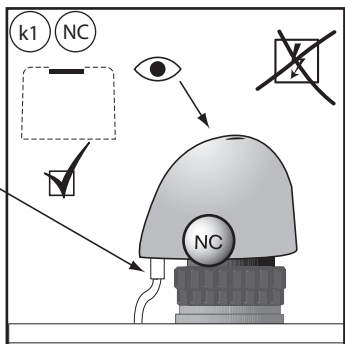
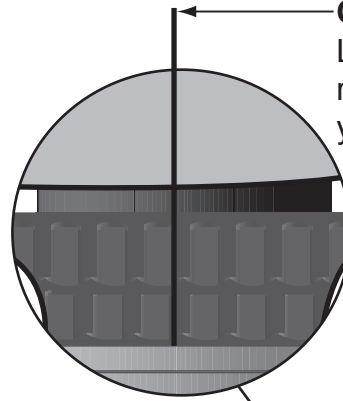

Please note:
Ensure that the wire plug is pushed hard into the socket so inner contacts are connected.





24Vac, ME1605, NO / ME1705 NC
 230Vac ME1625 NO / ME1725 NC

